

Model Number	Type Grille	Type Deflection	Deflection Degrees	Blade Spacing	Border Type	OS	FR	#01 #04	#20 #21 #26	#84	#34 #94 #95 #96	C	DS	IS	FG	PF	PFA	PFAP	EQT	
50F	AL-Return	Eggcrate	N/A	1/2" X 1/2" X 1/2" 1/2" X 1/2" X 1" 1" X 1" X 1"	1	Y	Y	Y	Y	Y	N	N	Y	Y	Y	Y	N	N	Y	
50F	AL-Return	Eggcrate	N/A	1/2" X 1/2" X 1/2" 1/2" X 1/2" X 1" 1" X 1" X 1"	3	N	N	Y	Y	Y	N	N	Y	Y	N	N	N	N	Y	
50F	AL-Return	Eggcrate	N/A	1/2" X 1/2" X 1/2" 1/2" X 1/2" X 1" 1" X 1" X 1"	7	N	Y	Y	Y	Y	N	N	N	N	N	N	N	N	Y	
50F	AL-Return	Eggcrate	N/A	1/2" X 1/2" X 1/2" 1/2" X 1/2" X 1" 1" X 1" X 1"	8	N	Y	Y	Y	Y	N	N	N	N	N	N	N	N	N	
50R-SS	304 SS-Return	Eggcrate	N/A	1/2" X 1/2" X 1/2"	1	Y	Y	Y	Y	Y	N	Y	N	N	Y	Y	Y	Y	N	Y
50F-NT	AL-Return	Eggcrate	N/A	1/2" X 1/2" X 1/2" 1/2" X 1/2" X 1" 1" X 1" X 1"	NT	N	N	Y	Y	Y	N	N	N	N	N	N	N	N	N	Y
50FF	AL-Filter Return	Eggcrate	N/A	1/2" X 1/2" X 1/2"	1	N	N	Y	Y	Y	N	N	N	N	Y	N	N	N	N	
50FF	AL-Filter Return	Eggcrate	N/A	1/2" X 1/2" X 1/2"	3	N	N	Y	Y	Y	N	N	N	N	N	N	N	N	N	Y
8R	Stl- Return	Perforated	N/A	3/16" Dia. Holes On 1/4" Centers	1	Y	Y	Y	Y	Y	N	Y	Y	Y	Y	Y	Y	Y	N	Y
8R	Stl- Return	Perforated	N/A	3/16" Dia. Holes On 1/4" Centers	3	N	N	Y	Y	Y	N	N	Y	Y	N	N	N	N	N	Y
8F	AL- Return	Perforated	N/A	3/16" Dia. Holes On 1/4" Centers	1	Y	Y	Y	Y	Y	N	Y	Y	Y	Y	Y	Y	Y	N	Y
8F	AL- Return	Perforated	N/A	3/16" Dia. Holes On 1/4" Centers	2	N	N	Y	Y	Y	N	N	Y	Y	N	N	N	N	N	Y
8F	AL- Return	Perforated	N/A	3/16" Dia. Holes On 1/4" Centers	3	N	N	Y	Y	Y	N	N	Y	Y	N	N	N	N	N	Y
8F	AL- Return	Perforated	N/A	3/16" Dia. Holes On 1/4" Centers	4	N	N	Y	Y	Y	N	N	Y	Y	N	N	N	N	N	Y
8SS*	304 SS-Return	Perforated	N/A	3/16" Dia. Holes On 1/4" Centers	1	Y	Y	Y	N	N	N	Y	N	N	Y	Y	Y	Y	N	Y
8RF	Stl- Filter Return	Perforated	N/A	3/16" Dia. Holes On 1/4" Centers	1	N	N	Y	Y	Y	N	N	N	N	Y	N	N	N	N	N
8RF	Stl- Filter Return	Perforated	N/A	3/16" Dia. Holes On 1/4" Centers	3	N	N	Y	Y	Y	N	N	N	N	N	N	N	N	N	Y
8FF	AL- Filter Return	Perforated	N/A	3/16" Dia. Holes On 1/4" Centers	1	N	N	Y	Y	Y	N	N	N	N	N	N	N	N	N	Y
8FF	AL- Filter Return	Perforated	N/A	3/16" Dia. Holes On 1/4" Centers	3	N	N	Y	Y	Y	N	N	N	N	Y	Y	N	Y	N	Y
33RL	HD Steel Return	Single	38	1/2"	1	Y	Y	Y	Y	Y	N	Y	Y	Y	Y	N	N	N	Y	Y
30RL	HD Steel Return	Single	0	"	1	Y	Y	Y	Y	Y	N	Y	Y	Y	Y	N	N	N	Y	Y
33RFL	HD Steel Filter Return	Single	38	1/2"	1	N	Y	Y	Y	Y	N	N	N	N	Y	N	N	N	N	N
30RFL	HD Steel Filter Return	Single	0	"	1	N	Y	Y	Y	Y	N	N	N	N	Y	N	N	N	N	Y
63FL	HD Aluminum Return	Single	30	1/2"	1	Y	N	Y	Y	Y	Y	N	Y	Y	Y	N	Y	N	Y	Y
60FL	HD Aluminum Return	Single	0	1/2"	1	Y	N	Y	Y	Y	Y	N	Y	Y	Y	N	Y	N	Y	Y
T-700	Stl - Door Grille	Single	77	1/2"	1	N	Y	Y	Y	Y	N	N	N	N	N	N	N	N	N	N
CT-700	AL-Door Grille	Single	77	1/2"	1	N	Y	Y	Y	Y	N	N	N	N	N	N	N	N	N	N
1700	AL-Supply Reversible Core	Single	5 up, 15 up, 5 down, 15 up	5/16"	1	N	N	Y	Y	Y	Y	N	Y	Y	Y	N	N	N	N	N
JFA	Stl-Supply-Gang Operated Rear Blades	Double	Adjustable	3/4" Front, 1" Rear	1	N	Y	Y	Y	Y	N	N	Y	Y	Y	N	N	N	N	N
DL	Drum Louver	Vertically Rotating Drum with Blades for Horizontal Adjustment	Adjustable	Varies	1	N	N	Y	Y	Y	N	N	N	N	N	N	N	N	N	N
S300	Direct Spiral Duct-Mounted w Radius End Caps	Double	Adjustable	3/4"	1	N	Y	Y	Y	Y	Y	N	Y	N	Y	N	N	N	N	N
S301	Direct Spiral Duct-Mounted w Radius End Caps	Single	Adjustable	3/4"	1	N	Y	Y	Y	Y	Y	N	Y	N	Y	N	N	N	N	N
US300	Direct Spiral Duct-Mounted w Universal Border	Double	Adjustable	3/4"	1	N	Y	Y	Y	Y	Y	N	Y	N	Y	N	N	N	N	N
US301	Direct Spiral Duct-Mounted w Universal Border	Single	Adjustable	3/4"	1	N	Y	Y	Y	Y	Y	N	Y	N	Y	N	N	N	N	N
S8F	Direct Spiral Duct-Mounted w Radius End Caps	Perforated	N/A	3/16" Dia. Holes On 1/4" Centers	1	N	Y	Y	Y	Y	Y	N	Y	N	Y	N	N	N	N	N
US8F	Direct Spiral Duct-Mounted w Universal Border	Single	Adjustable	3/4"	1	N	Y	Y	Y	Y	Y	N	Y	N	Y	N	N	N	N	N

* Note: 8SS only available with 04 and 26 finishes. Caution: All options are not available in all combinations. Check with your Titus representative for details. Titus reserves the right to discontinue or add options at any time without notice.

SERIES FINISHES, OPTIONS AND ACCESSORIES

Finishes:		Options And Accessories:			
#01	Aluminum Colored Paint*	OS	Oversize	PF-SS	Stainless Steel Plaster Frame
#04	Mill Finish	FR	Fractional Size	EQT	Earthquake Tab For Safety Wiring to Support Structure
#20	Envirotherm Color To Match Sample*	C	Concealed Fasteners	SRG	Square-to-Round Adapter for Grilles
#21	Envirothane Color To Match Sample*	DS	Debris Screen 1/4" Square Mesh		
#25	Off White*		Galvanized Steel Screen		
#26	White (standard on most models)	IS	Insect Screen 1/16" Square Mesh		
#34	Clear Anodized*		Galvanized Steel Screen		
#84	Black*	FG	Foam Gasket On Back Side of Border		
#94	Light Bronze Anodized*	PF	Steel Plaster Frame		
#95	Medium Bronze Anodized*	PFA	Aluminum Plaster Frame		
#96	Dark Bronze Anodized*				

Note: An asterisk (*) indicates additional cost

BORDER TYPES

**BORDER TYPE 2
SNAP-IN (PANEL MOUNTED)**

Available Module Sizes
24 x 24 inches

Snap-In

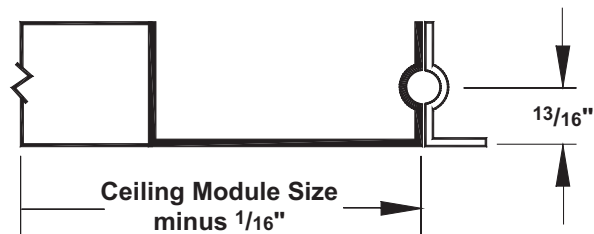

Note: Maximum grille area is module size minus 4 inches

**BORDER TYPE 3
LAY-IN (PANEL MOUNTED)**

Available Module Sizes
12 x 12 inches 24 x 12 inches
36 x 12 inches 48 x 12 inches
24 x 24 inches 36 x 24 inches
48 x 24 inches

Lay-In (Panel Mounted)

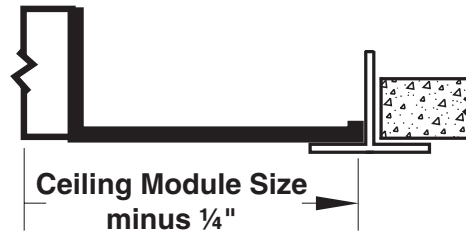

Note: Maximum grille area is module size minus 4 inches

**BORDER TYPE 4
SPLINE (PANEL MOUNTED)**

Available Module Sizes
24 x 24 inches

Note: Filter grilles not available in all module sizes.

Spline (Panel Mounted)

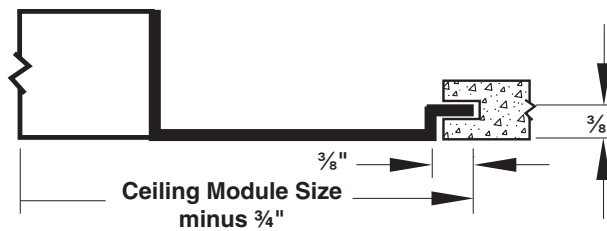

Note: Maximum grille area is module size minus 4 inches

**BORDER TYPE 7(MODEL 50F ONLY)
CHANNEL FRAME**

Available Module Sizes
6 x 4 inches through 48 x 48 inches in 2" increments.

Channel Frame

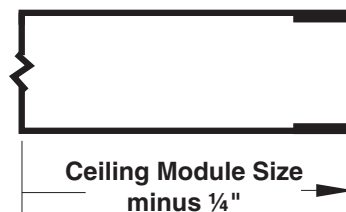

Note: Maximum grille size is 48 x 48 inches

**BORDER TYPE NT
NARROW TEE (PANEL MOUNTED)**

Available Module Sizes
24 x 12 inches 24 x 24 inches

Narrow Tee (Panel Mounted)

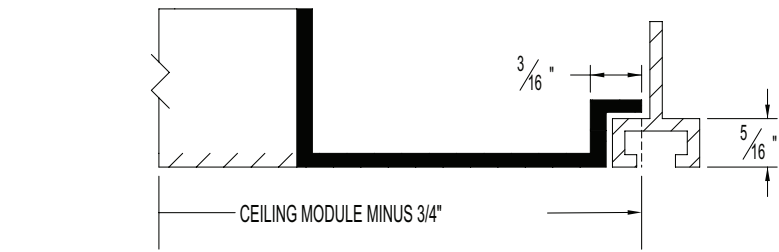

ACCESSORIES

TYPE A FASTENING - SURFACE MOUNT

- Standard For All Border Type
1 Surface Mount Grilles
- Note: For screw hole locations see the chart, "Screw Hole Location Chart"

TYPE C FASTENING - CONCEALED MOUNTING

- Available on Most Models
with Border Type 1

Type A / External Screw

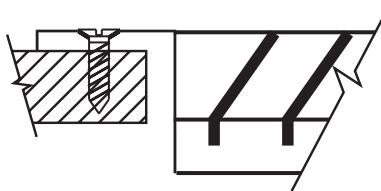

Type C / Concealed Screw

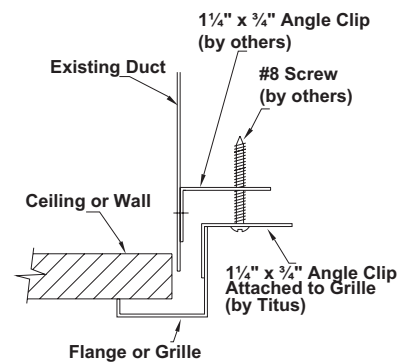

SQUARE-TO-ROUND ADAPTER FOR GRILLES (SRG)

Available Module Sizes
24 x 24 inches

- 24 gauge galvanized steel construction
- Flat black finish
- 2-1/2" beaded inlet
- Factory assembled to grille

Square-to-Round Adapter for Grilles (SRG)

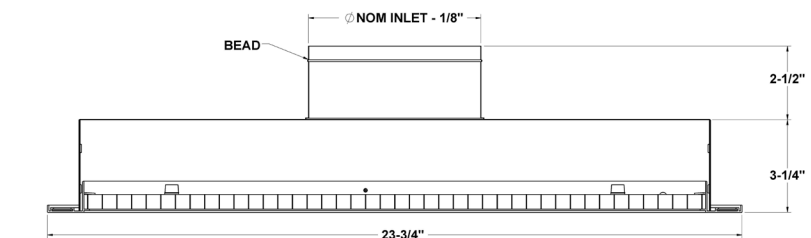

24 x 24 Module Size	
Nominal Grille Size	Nominal Round Inlet Size
22 x 22	6
	8
	10
	12
	14
	16
	18
20	